

Power Flame introduces a new Sub 30 PPM burner without FGR

Power Flame is pleased to announce our latest offering in the energy efficient low NOx market. Our next EVOLution of burners is an innovative design with "Patent Pending" staged/premix combustion technology to maximize operating efficiency and

reduce NOx emissions on natural gas firing below 30 PPM without the use of flue gas recirculation (FGR). Designed to fire a range of gaseous fuels and light oil, the EVO™ Burner utilizes a unique firing head design which provides stable combustion over a wide

EVO™

Sub 30 PPM NO FGR

turndown. The combination of operating at **3% excess oxygen** and **sub 30 PPM NOx** revolutionizes the burner market. Currently available from **40 to 1500 BHP**, the EVO™ will fire on a wide range of boilers and heat exchangers.

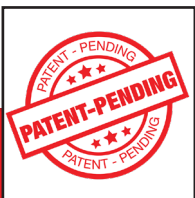
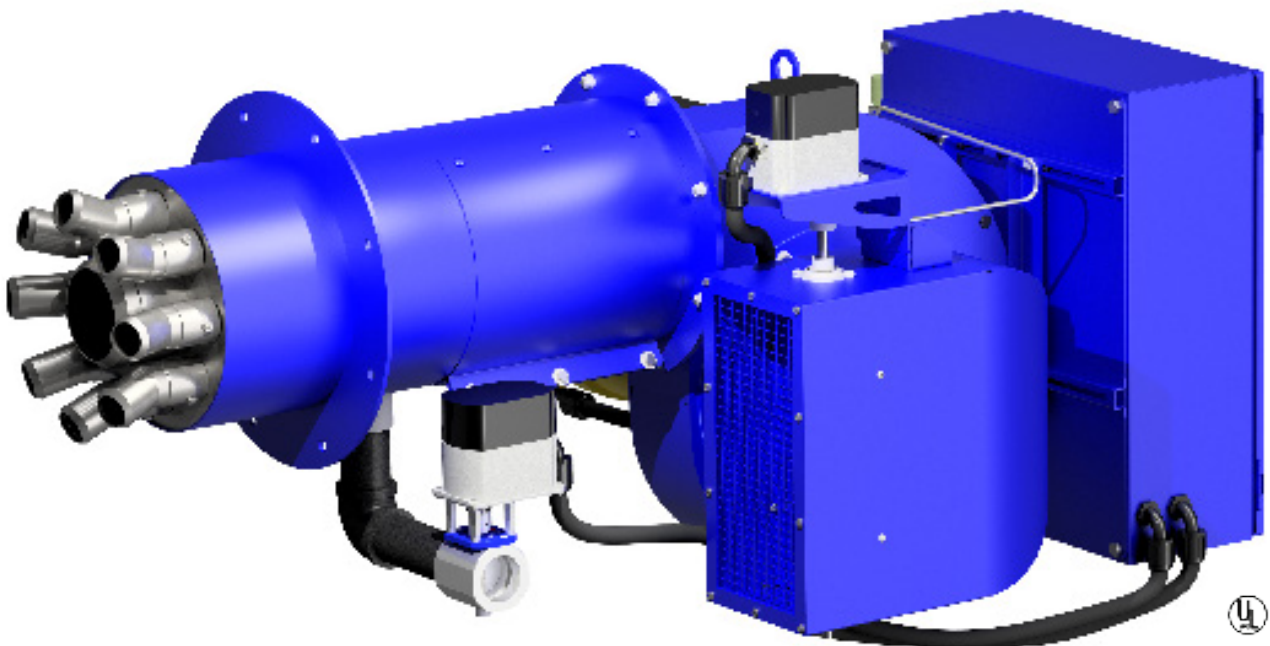

CALL US: 620-421-0480
VISIT: WWW.POWERFLAME.COM
EMAIL: CSD@POWERFLAME.COM

POWER FLAME INCORPORATED
2001 S. 21ST ST. PARSONS, KS 67357
FOLLOW US:    

STANDARD EQUIPMENT

- Siemens LMV3/5 Linkageless controls
- Integral flame safeguard and UV scanner
- Siemens gas train with regulator
- Gas electric pilot, ignition transformer, and pilot train
- Combustion air flow switch
- Burner mounted control panel
- Five indicating lights and On-Off switch
- Siemens AZL display

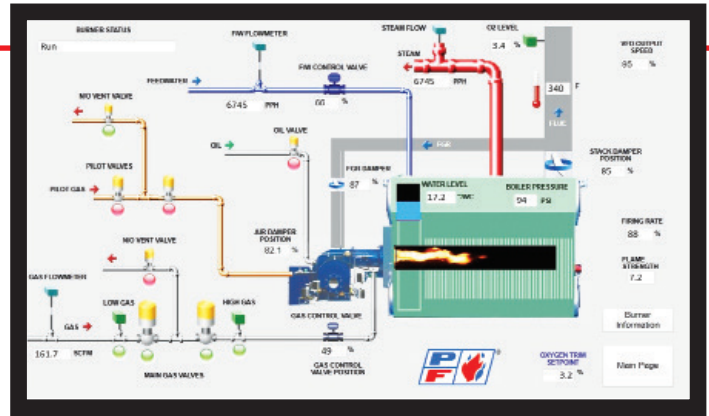

Optional Director SCS Fully Integrated Boiler Room PLC Control System

(EVO™ MODELS 200 – 800)

(EVO™ MODEL 150)

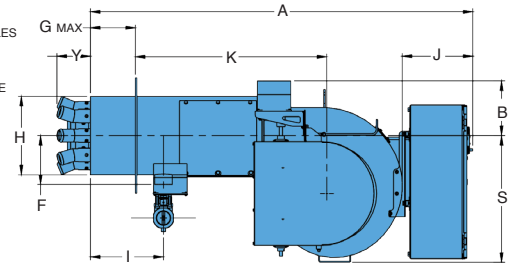
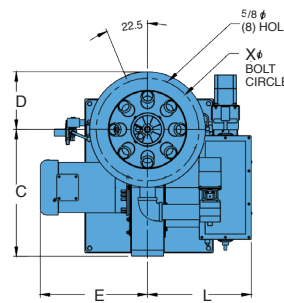
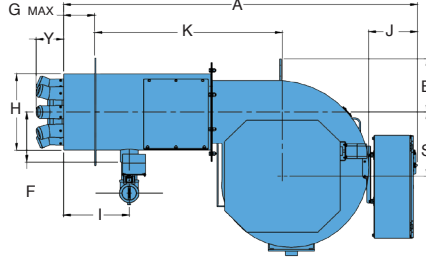
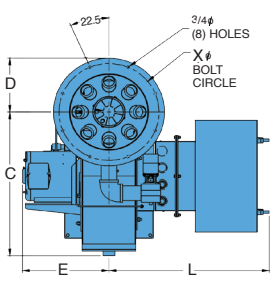

DIMENSIONS (Inches) Standard Models.

RATINGS & SPECIFICATIONS

Burner Model	A	B	C	D	E	F	G	H	I	J	K	L	S	X	Y	CAPACITY*				GAS** PRESS. REQ'D (IN. WC)
																# 2 OIL GPH MAX.	NAT. GAS MBH MAX.	NOMINAL BOILER H.P. MAX.	BLOWER MOTOR H.P.	
EVO150-G-30	60	8 1/2	19 3/4	9	16 23/32	7 19/32	8	12 7/32	11 3/8	11	28 13/16	16 5/32	9 1/32	16	5 7/32	45	6,300	150	7.5	30
EVO200-G-30	76	12 11/32	33 3/8	10 1/2	15 3/32	10 1/32	8	14 15/32	12 3/4	10 15/16	37 5/32	35 13/32	14 29/32	18 1/2	5 23/32	58	8,400	200	15.0	32
EVO250-G-30	76	12 11/32	33 3/8	10 3/4	15 19/32	10 9/32	8	14 31/32	12 3/4	10 15/16	37 5/32	35 13/32	14 29/32	19	5 23/32	75	10,500	250	15.0	30
EVO300-G-30	79	12 11/32	33 3/8	11 7/8	16 3/32	11 1/32	9	16 15/32	13 3/4	10 15/16	39 5/32	35 13/32	14 29/32	21 1/4	5 23/32	90	12,600	300	15.0	32
EVO350-G-30	80	12 11/32	33 3/8	12 1/2	19 15/32	11 21/32	10	17 23/32	14 3/4	10 15/16	39 5/32	36 1/32	14 29/32	22 1/2	6 3/16	103	14,700	350	20.0	38
EVO400-G-30	81	12 11/32	33 3/8	12 1/2	20 7/32	12 9/32	11	18 31/32	14 3/4	10 15/16	39 5/32	36 1/32	14 29/32	22 1/2	6 3/16	120	16,800	400	20.0	36
EVO500-G-30	86	14 1/8	36 1/16	14 1/2	21 3/32	13 13/32	13	21 7/32	17 3/4	11 1/32	40 25/32	36 13/32	16 5/32	26	6 19/32	150	21,000	500	25.0	42
EVO600-G-30	87	14 1/8	36 1/16	16	21 3/32	14 13/32	14	23 7/32	18 3/4	11 1/32	40 25/32	36 13/32	16 5/32	29	6 19/32	180	25,200	600	25.0	38
EVO700-G-30	90	15 13/16	37 11/16	16 1/2	26 23/32	15 9/32	15 1/4	24 31/32	20	10 15/16	41 5/32	36 3/4	16 19/32	31	7 3/32	206	29,400	700	30.0	42
EVO800-G-30	91	15 13/16	37 11/16	17 1/2	24 13/16	16 5/32	17	26 23/32	21 3/4	10 15/16	41 5/32	36 3/4	16 19/32	33	7 3/32	240	33,600	800	40.0	48

NOTES: Dimensions can vary with optional equipment and system arrangements. Final piping connections should be determined after installation.

* PFI certified capacities listed are based on +1.5" w.c. (EVO™ 150 – 250) / +3.5" w.c. (EVO™ 300 – 500) / +5.5" w.c. (EVO™ 600 – 800) combustion chamber pressure.

** Gas pressures listed are at the inlet to the main shutoff cock and required to obtain PFI certified rating with the standard Siemens gas train. Optional gas trains are available for lower pressures.

*** Refer to O&M manual for proper insertion depth and burner opening dimensions.

CALL US:
VISIT:
EMAIL:

620-421-0480
WWW.POWERFLAME.COM
CSD@POWERFLAME.COM

POWER FLAME INCORPORATED
2001 S. 21ST ST. PARSONS, KS 67357
FOLLOW US:

